

**REDARC**

**SOLAR**

# Solar Regulator

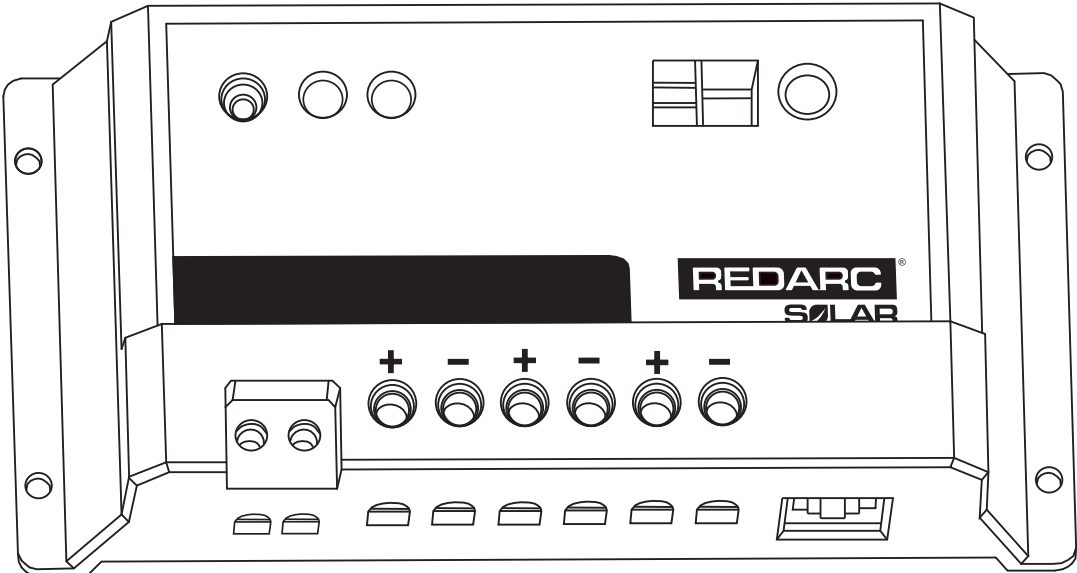

# THE SOLAR REGULATOR

---

REDARC solar regulators ensure that the power supplied by your solar panels is at the right voltage to charge your house or auxiliary batteries.

Our regulators are suitable for charging up to two separate battery banks and come in both 10A and 20A models.

## WARNING & SAFETY INSTRUCTIONS

---

This appliance is not intended for use by persons (including children) with reduced physical, sensory or mental capabilities, or lack of experience and knowledge, unless they are supervised or have been instructed on how to use the appliance by a person responsible for their safety. Children should be supervised to ensure that they do not play with the appliance.

Do NOT use the Regulator to charge non-rechargeable batteries. Doing so may result in harm to the user and/or damage to the Regulator and/or Solar Panel. Only use the Regulator for charging Standard Lead Acid, Calcium content, Gel & AGM type 12V batteries.

All lead acid batteries produce harmful, explosive gases. The Battery should be mounted in a well ventilated area, as far as possible from any ignition sources. Do NOT smoke when in the vicinity of the battery under charge.

Battery acid is a harmful substance. Care should be taken when working with lead acid batteries, if the acid comes into contact with your eyes or skin, immediately wash the affected area with cold running water and seek medical assistance. Eye protection and gloves should be worn when handling lead acid batteries.

The Regulator will achieve best results when proper battery maintenance is regularly performed. This includes but is not limited to checking water and specific gravity levels of the battery.

**Warning!** Check the manufacturers data for your battery and ensure that the 'Maximum' voltage of the profile you select does not exceed the manufacturers recommended maximum charging voltage. If the 'Maximum' voltage for your battery type is too high, please select another charging profile.

# SPECIFICATIONS

## DIMENSIONS

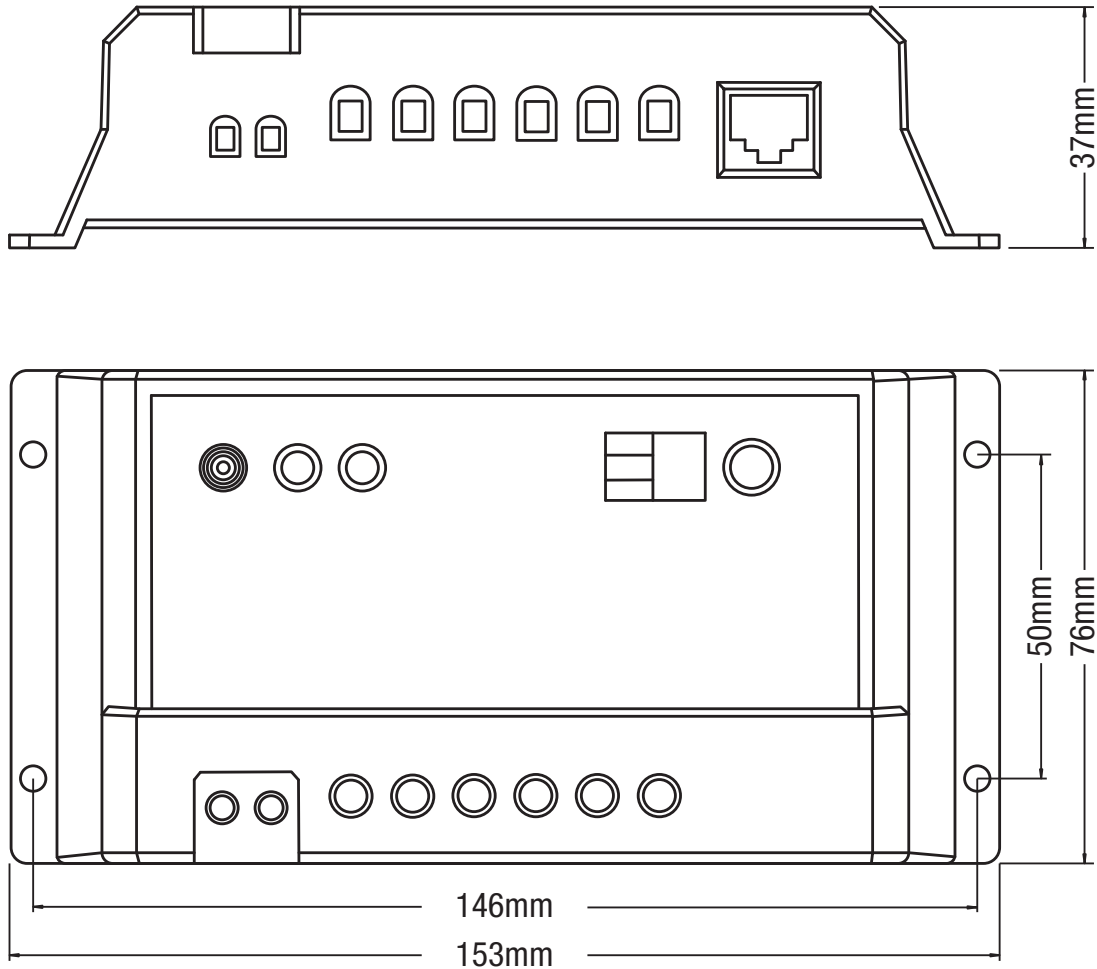

## GENERAL SPECIFICATIONS

	AGM/Gel	Standard lead Acid	Calcium Content
Maximum voltage*	14.4V	14.6V	14.8V
Float Voltage*	13.6V	13.6V	13.6V
Maximum Input Voltage	30V		
Battery Voltage Range	9 -15V		
Boost Time	2 hours		
Standby Current Draw	4mA		
Nominal Current Draw	10mA		
Remote Connection	8-pin RJ-45		
Temp. Compensation	-30mV/12V/°C		
Terminals	4mm <sup>2</sup>		
Operating Temp.	-35°C to +50°C		

\*Charge profile voltages will change with temperature compensation

# THE SOLAR REGULATOR

## REGULATOR FUNCTION

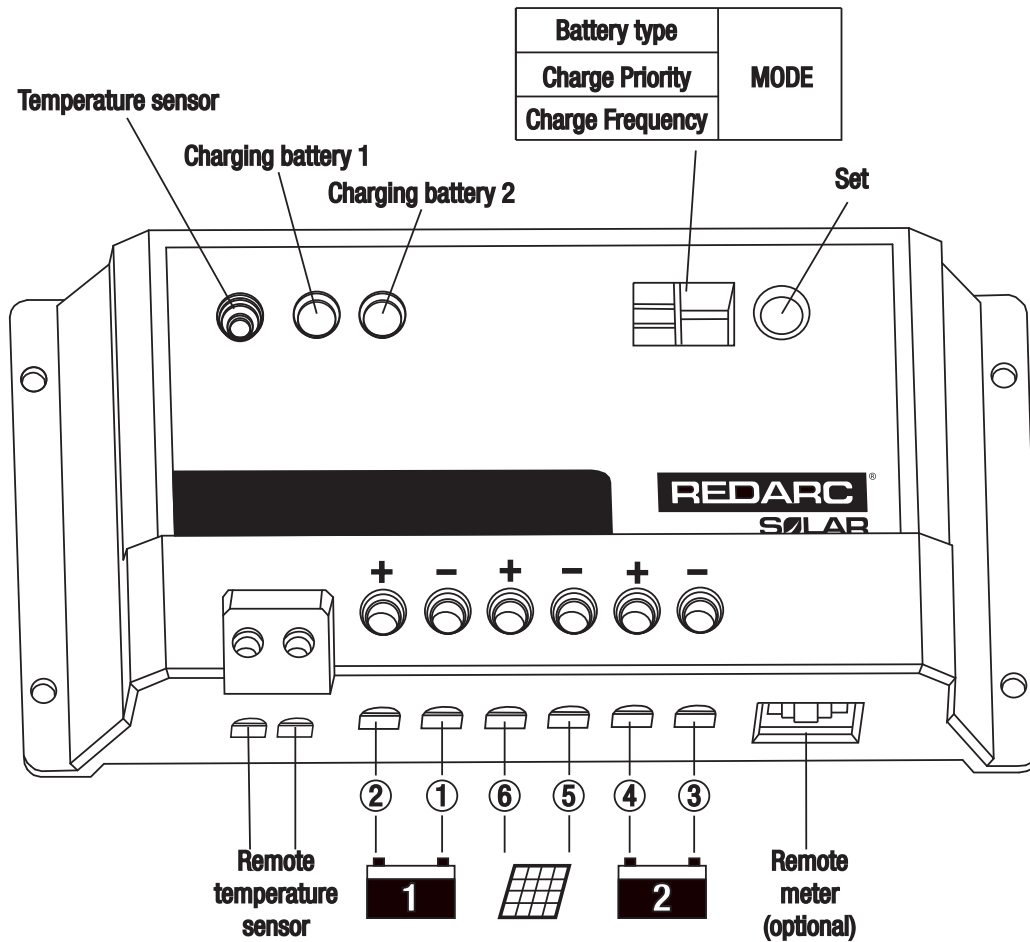

## CONNECTION

The regulator should be connected to the battery according to the diagram above. The connection order is indicated by the numbers circled. ①

Incorrect connection of the battery can damage the regulator.

The Remote temperature sensor is optional and the regulator will still operate without it connected.

The Remote monitor is optional and the regulator will still operate without it connected.

## INDICATION

- |                           |   |
|---------------------------|---|
| 1. LED flash (fast)       | Short circuit - check the Solar panel and the battery to make sure that they are connected correctly. |
| 2. LED flash (slow)       | Fully charged.  |
| 3. LED ON                 | Charging.   |
| 4. LED flash (occasional) | Battery connected, no charge current.   |
| 5. LED OFF                | No connection or Over voltage - Check wires, reduce current draw (load), reset the controller.        |

---

## SETTING MODES

1. Press the Set button to start the mode select process.
2. Press the Set button to cycle through to the mode required.
  - Battery Type
  - Charge Priority
  - Charge Frequency
3. Once the correct mode is selected, press and hold the Set button for 5 seconds, until the LED and setting begin to flash, to change the setting for the selected mode.
4. Press the Set button to cycle through the settings.
5. Once the desired setting is selected, leave the Set button for 5 seconds to save the setting and return to the mode select process.
6. Once all modes have been set, leave the Set button for 5 seconds and the mode select process will end.

## MODES

### 1st LED - Battery type

Setting	Battery Type
1	AGM/Gel
2	Lead Acid
3	Calcium

### 2nd LED - Charge Priority

Setting	Battery 1 %	Battery 2 %
0	0%	100%
1	10%	90%
2	20%	80%
3	30%	70%
4	40%	60%
5	50% (Factory set)	50%
6	60%	40%
7	70%	30%
8	80%	20%
9	90%	10%

### 3rd LED - Charge Frequency

Setting	PWM Frequency
0	25Hz (Factory set)
1	50Hz

When setting the charge priority only Battery 1 % needs to be set. Battery 2 % is automatically calculated by the regulator.

During normal charging the regulator will divide the charging as per the settings. If Battery 1 is fully charged, more charge will go to Battery 2. If Battery 2 is disconnected all the charge current will go to Battery 1.

If MODE LED flashes 'H', the temperature exceeds 55°C and the units temperature protection is active. The unit will restart once the temperature is within safe limits.

# SYSTEM SETUP

---

## INSTALLATION NOTES

- Always connect the battery/s first (before the panel)
- Always ensure the connection to the battery terminals is sound, with as much surface contact between the battery terminal and the connection method (ie alligator clips) as possible.
- Do NOT expose regulator to rain, snow, spray. For optimum operation, the regulator should be mounted where the temperature is nominally below 45°C and does not exceed 55°C.
- The regulator should be installed as close as possible to the battery/s, using the cables provided ensures that the distance from the battery is suitable. If you need to use different cables ensure their length does not exceed that of the cables provided.
- If 2 batteries are installed, they must be of the same chemical characteristics ie. both of Calcium content or both of AGM type.
- The recommended MC4 connectors are suitably rated for up to 30A, if multiple panels are used to the point of exceeding this rating, alternative connectors and regulator should be sourced.
- When connecting panels from an existing setup, or non-Redarc brand panels, please ensure that the panels are diode protected, as they may be damaged if they are not.
- Charge frequency is set to 25Hz as a factory setting. It is not recommended to change this setting unless absolutely necessary. If you are unsure as to what this setting should be, please leave as 25Hz.
- Always check the manufacturers data for your battery and ensure that the 'Maximum' voltage of the profile you select does not exceed the manufacturers recommended maximum charging voltage. If the 'Maximum' voltage for your battery type is too high, please select another charging profile.
- Do NOT exceed the rated current/wattage of the regulator.
- Do NOT connect solar panel to chassis.battery ground.

## NOTES:

- Incorrect connection of dual battery polarities can damage the controller.
- Ensure the recommended connection sequence is followed.

## ACCESSORIES

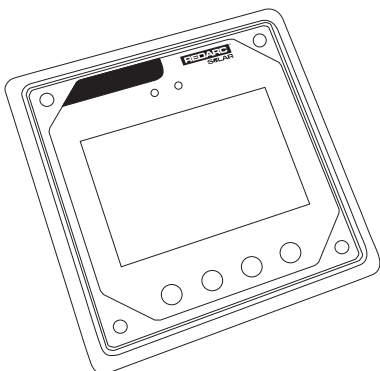

### SRP0240-RM

Remote Monitor  
for SRP0120 and  
SRP0240.

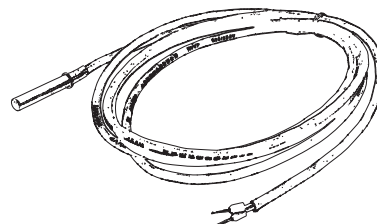

### SRP0240-TS

Remote Temperature  
Sensor for SRP0120  
and SRP0240.

# STANDARD SETUP

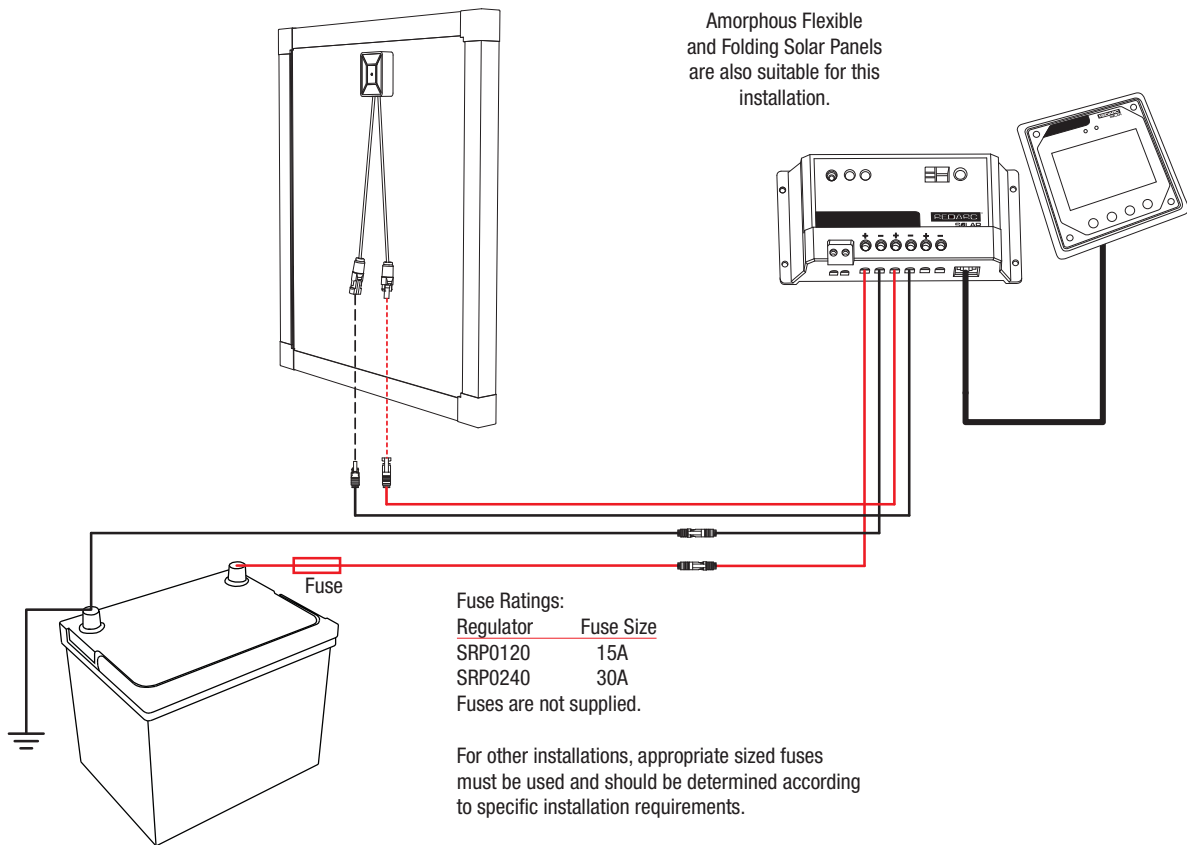

## Setup for a single AGM or Gel type battery.

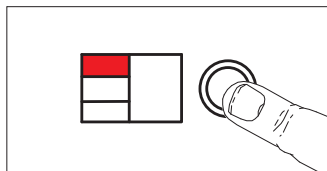

Press the 'Set' button and cycle until the first LED is on (Battery Type).

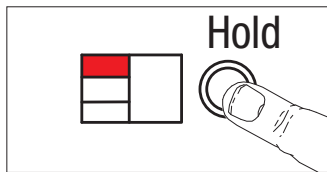

Press and hold the 'Set' button for 5 seconds to enter the setting change state for mode Battery Type.

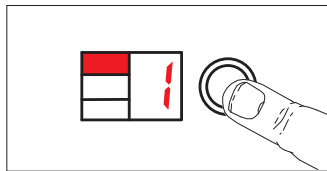

Press the 'Set' button until the number '1' appears as the setting value. (Set for AGM or Gel)

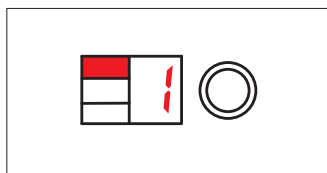

Leave the 'Set' button for 5 seconds to save the setting.

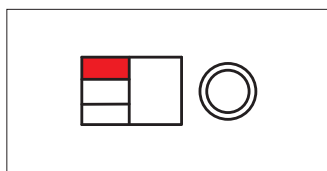

Leave the 'Set' button for 5 seconds to exit mode select.

The Charge Priority does not need to be set for a 1 battery setup as under these circumstances the battery that is connected will receive 100% of the charge.

NOTE: Charge frequency is set to 25Hz as a factory setting. It is not recommended to change this setting unless absolutely necessary. If you are unsure as to what this setting should be, please leave as 25Hz.

# SYSTEM SETUP

## DUAL BATTERY SETUP

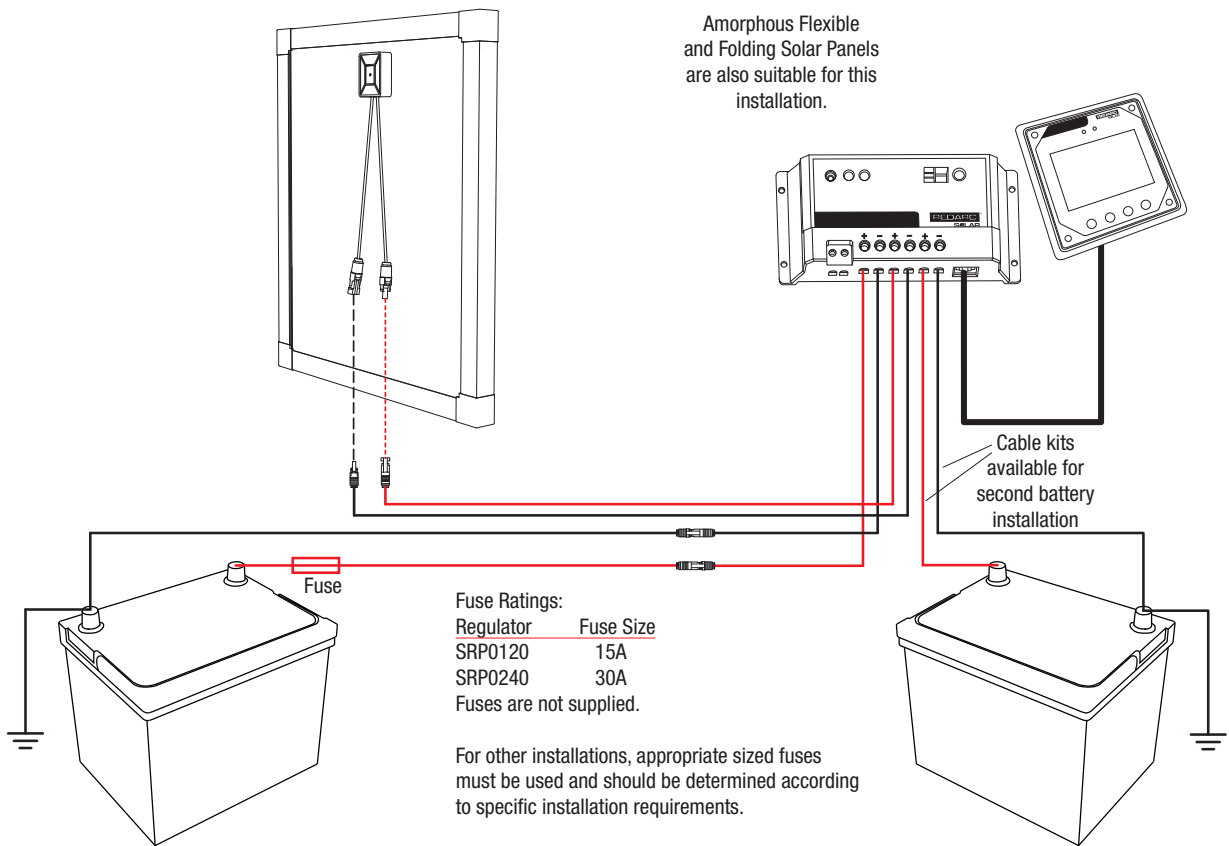

### Setup for standard lead acid batteries, 70% charge priority to battery 1.

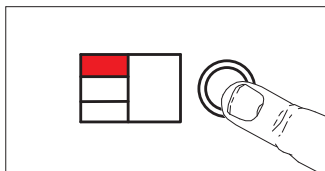

Press the 'Set' button and cycle until the first LED is on (Battery Type).

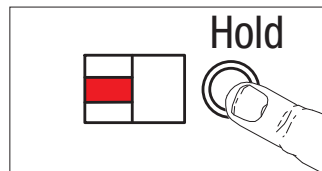

Press and hold the 'Set' button for 5 seconds to enter the setting change state for mode Charge Priority.

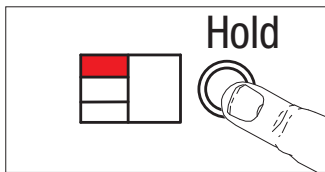

Press and hold the 'Set' button for 5 seconds to enter the setting change state for mode Battery Type.

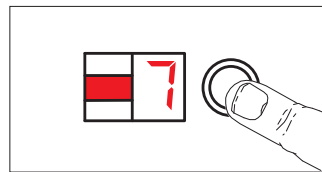

Press the 'Set' button until the number '7' appears as the setting value.

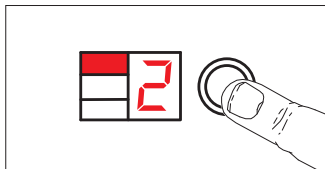

Press the 'Set' button until the number '2' appears as the setting value. (Set for Std. Lead Acid)

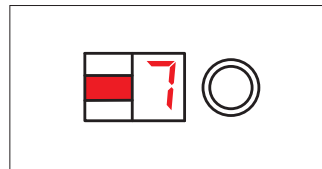

Leave the 'Set' button for 5 seconds to save the setting.

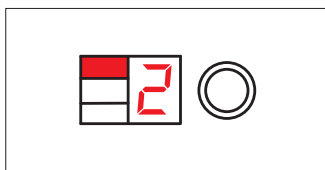

Leave the 'Set' button for 5 seconds to save the setting.

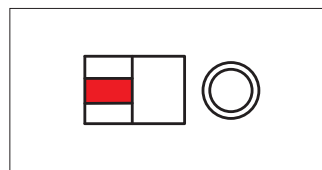

Leave the 'Set' button for 5 seconds to exit mode select.

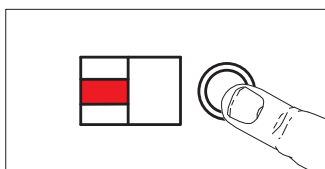

Press the 'Set' button and cycle until the second LED is on (Charge Priority).



# DUAL BATTERY SETUP WITH DUAL SOLAR PANELS

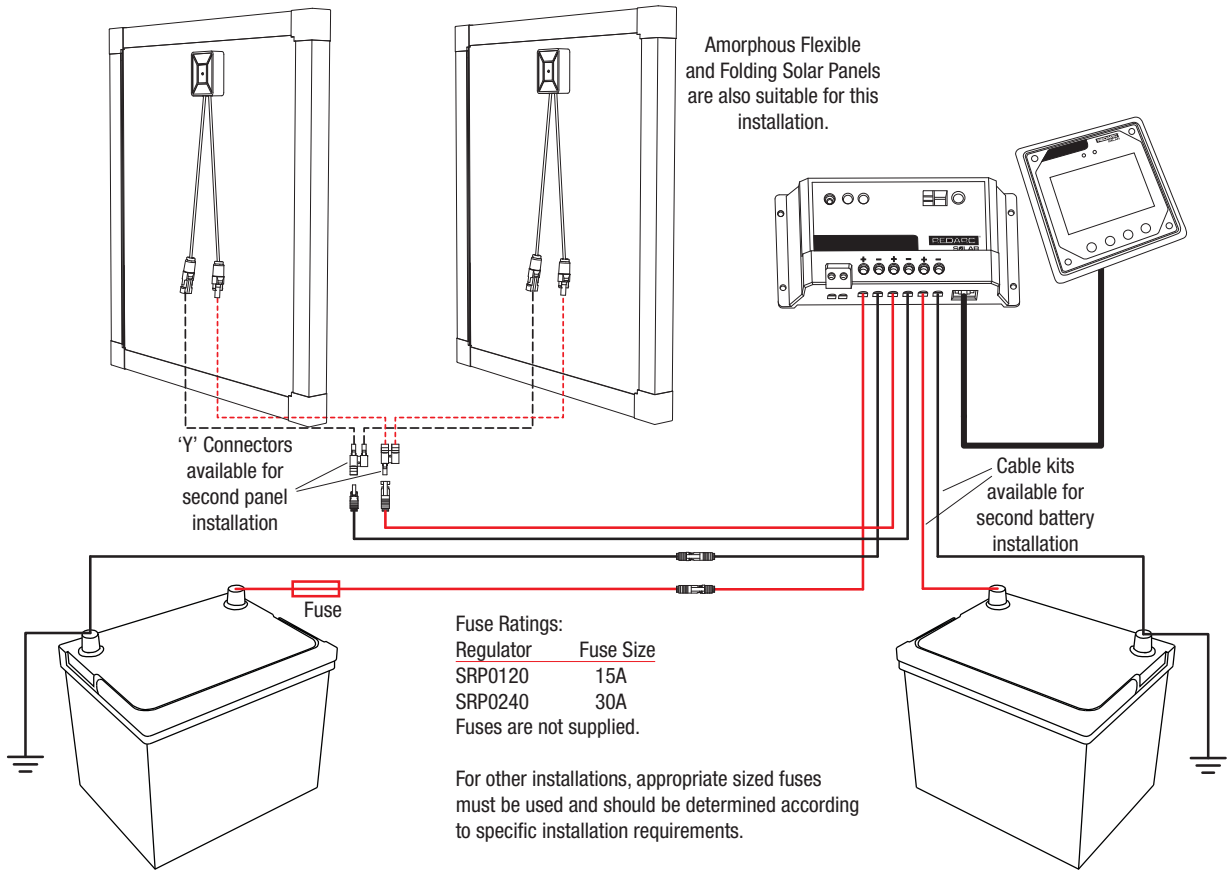

## Setup for calcium content batteries, 40% charge priority to battery 1.

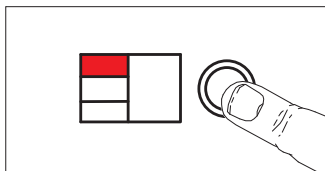

Press the 'Set' button and cycle until the first LED is on (Battery Type).

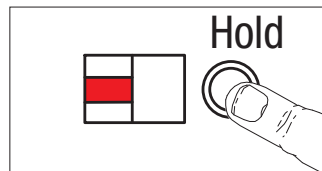

Press and hold the 'Set' button for 5 seconds to enter the setting change state for mode Charge Priority.

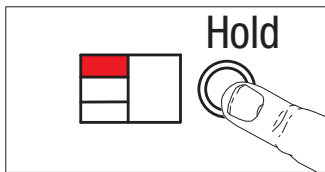

Press and hold the 'Set' button for 5 seconds to enter the setting change state for mode Battery Type.

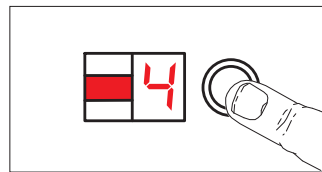

Press the 'Set' button until the number '4' appears as the setting value.

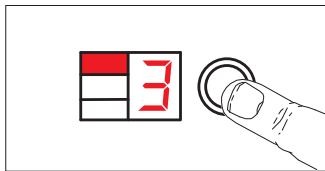

Press the 'Set' button until the number '3' appears as the setting value. (Set for Calcium Content)

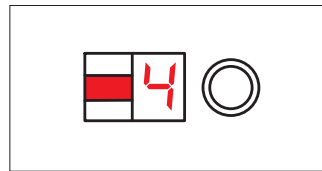

Leave the 'Set' button for 5 seconds to save the setting.

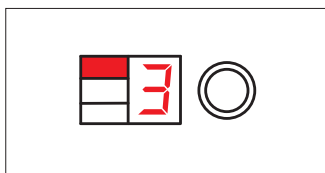

Leave the 'Set' button for 5 seconds to save the setting.

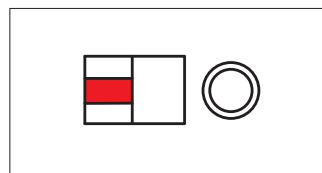

Leave the 'Set' button for 5 seconds to exit mode select.

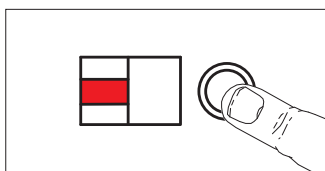

Press the 'Set' button and cycle until the second LED is on (Charge Priority).

# REDARC SOLAR PRODUCT WARRANTY

Over the last three decades our company has established a reputation as the power conversion specialist.

A 100% Australian-owned company, we have met the needs of customers in transport and other industries through exciting, innovative thinking.

We believe in total customer satisfaction and practice this by offering our customers:

- Technical advice free of jargon and free of charge
- Prompt turnaround of orders throughout Australia and globally
- Friendly, personalised, professional service and product support

In the unlikely event that a technical issue arises with a Redarc product, customers are encouraged to initially contact the Redarc Technical Support Team on (08) 8322 4848 or [power@redarc.com.au](mailto:power@redarc.com.au) for prompt and efficient diagnosis and product support.

Our goods come with guarantees that cannot be excluded under the Australian Consumer Law. You are entitled to a replacement or refund for a major failure and compensation for any other reasonably foreseeable loss or damage. You are also entitled to have the goods repaired or replaced if the goods fail to be of acceptable quality and the failure does not amount to a major failure.

The benefits of this Warranty are in addition to other rights and remedies available at law in respect of the Solar Products and shall not derogate from any applicable mandatory statutory provisions or rights under the Australian Consumer Law.

Redarc Electronics Pty Ltd atf the Redarc Trust trading as Redarc Solar ("**Redarc**") offers a warranty in respect of its Solar Products where the Solar Products are purchased from an authorised Redarc Solar distributor or reseller by a person ("**Purchaser**"), on the terms and conditions, and for the duration, outlined below in this document ("**Warranty**").

1. In this Warranty, the term **Solar Products** means:

- 1.1 Redarc Solar Monocrystalline Solar Panels;
  - 1.2 Redarc Solar Monocrystalline Folding Portable Solar Panel Kits;
  - 1.3 Redarc Solar Monocrystalline Folding Solar Panels;
  - 1.4 Redarc Solar Amorphous Flexible Solar Panels;
  - 1.5 Redarc Solar Amorphous Folding Solar Panels;
- (collectively the "**Modules**");
- 1.6 Redarc Solar Regulators and Displays;
  - 1.7 all other solar products manufactured or supplied by Redarc that are designed for use in recreational vehicles and boats, not otherwise specifically referred to in this clause 1; and
  - 1.8 any component of or accessory for any product in clause 1.1 to 1.7 (inclusive) manufactured or supplied by Redarc.

## Offer and duration of product warranties

2. Subject to this clause 2, Redarc warrants that its Solar Products will be free, under normal application, installation, use and service conditions, from defects in materials and workmanship affecting normal use, for the relevant periods set out below:

- 2.1 Redarc Solar Monocrystalline Solar Panels – 5 years from the date of purchase;
- 2.2 Redarc Solar Monocrystalline Folding Portable Solar Panel Kits – 5 years from the date of purchase;
- 2.3 Redarc Solar Monocrystalline Folding Solar Panels – 2 year from the date of purchase;;
- 2.4 Redarc Solar Amorphous Flexible Solar Panels – 2 years from the date of purchase;
- 2.5 Redarc Solar Amorphous Folding Solar Panels – 2 years from the date of purchase;
- 2.6 Redarc Solar Regulators and Displays – 2 years from the date of purchase; and
- 2.7 all other Solar Products not otherwise set out in this clause 2 – 2 years from the date of purchase.

3. Where a Solar Product malfunctions (excluding as a result of a reduction in power output levels, which is the subject of clause 4) or becomes inoperative during the relevant warranty period applicable to that Solar Product pursuant to clause 2, due to a defect in materials or workmanship, as determined by Redarc, then subject to further rights conferred by the Australian Consumer Law on the Purchaser, Redarc will, in exercise of its sole discretion, either:

- 3.1 repair the defective Solar Product;
- 3.2 replace the defective Solar Product; or
- 3.3 provide a refund to the Purchaser for the purchase price paid for the defective Solar Product,

without charge to the Purchaser.

4. Redarc warrants that:

- 4.1 if any Redarc Solar Monocrystalline Solar Panels or any Redarc Solar Monocrystalline Folding Portable Solar Panel Kits exhibit a power output of less than 80% of Peak Power under Standard Test Conditions, within 25 years of the date of purchase;
- 4.2 if any Redarc Solar Monocrystalline Folding Solar Panels, Redarc Solar Amorphous Flexible Solar Panels or any Redarc Solar Amorphous Folding Solar Panels exhibit a power output of less than 80% of Peak Power under Standard Test Conditions, within 5 years of the date of purchase; and such loss of power is determined by Redarc to be due to a defect in materials or workmanship, then subject to further rights conferred by the Australian Consumer Law on the Purchaser, Redarc will, in exercise of its sole discretion, either:
  - 4.3 make up the loss in power by supplying the Purchaser with relevant additional Modules; or
  - 4.4 repair or replace the defective Modules, without charge to the Purchaser.

5. For the purposes of clause 4:

- 5.1 Peak Power means the minimum peak power level in Watts that a Module generates in its maximum power point (as stated on the label affixed to the Module or on the product information sheet accompanying the Module); and
- 5.2 **Standard Test Conditions** means:

- (a) light spectrum of AM 1.5;
- (b) an irradiation of 1,000 Watts per square metre; and
- (c) a cell temperature of 25 degrees centigrade at right angle irradiation,

the measurements being carried out in accordance with IEC61215 as tested at the connectors or junction box terminals (as applicable) per the calibration and testing standards of Redarc in effect on the date of manufacture of the Module.

6. The warranties given by Redarc in clauses 2 to 4 cover the reasonable costs of delivery and installation of any repaired or replaced Solar Products or components of Solar Products to the Purchaser's usual residential address notified to Redarc, together with the reasonable costs of removal and return of any Solar Products determined by Redarc to be defective.

7. If the Purchaser incurs expenses of the nature referred to in clause 6 in the context of making a claim pursuant to this Warranty that is accepted by Redarc, the Purchaser will be entitled to claim for reimbursement of those expenses which Redarc determines, in exercise of its sole

discretion, to be reasonably incurred, provided that the claim is notified to Redarc in writing at the postal address or email address specified in clause 23 and includes:

- 7.1 details of the relevant expenses incurred by the Purchaser; and
- 7.2 proof of the relevant expenses having been incurred by the Purchaser.

#### **Exclusions and limitations**

8. This Warranty will not apply to, or include any defect, damage, fault, failure or malfunction of a Solar Product, which Redarc determines to be due to:
  - 8.1 normal wear and tear or exposure to weather conditions over time;
  - 8.2 accident, misuse, abuse, negligence, vandalism, alteration or modification;
  - 8.3 non-observance of any of the instructions supplied by Redarc, including instructions concerning installation, configuring, connecting, commissioning, use or application of the Solar Product, including without limitation choice of location;
  - 8.4 failure to ensure proper maintenance of the Solar Product strictly in accordance with Redarc's instructions or failure to ensure proper maintenance of any associated equipment or machinery;
  - 8.5 repairs to the Solar Product that are not strictly in accordance with Redarc's instructions;
  - 8.6 installation, repairs or maintenance of the Solar Product by, or under the supervision of, a person who is not a qualified auto electrician or technician, or if non-genuine or non-approved parts have been fitted;
  - 8.7 faulty power supply, power failure, electrical spikes or surges, lightning, flood, storm, hail, extreme heat, fire or other occurrence outside the control of Redarc;
  - 8.8 use other than for any reasonable purpose for which the Solar Product was manufactured;
  - 8.9 any indirect or incidental damage of whatever nature outside the control of Redarc.
9. Warranty claims in respect of a Solar Product must be made in writing to Redarc at the postal address or email address specified in clause 23 within the relevant warranty period applicable to that Solar Product pursuant to clause 2 or clause 4. Such claims must include the following:
  - 9.1 details of the alleged defect or fault and the circumstances surrounding the defect or fault;
  - 9.2 evidence of the claim, including photographs of the Solar Product (where the subject of the claim is capable of being photographed);
  - 9.3 the serial number of the Solar Product, specified on the label affixed to the Solar Product; and
  - 9.4 proof of purchase documentation for the Solar Product from an authorised distributor or reseller of Redarc, which clearly shows the date and place of purchase.The return of any Solar Products without the prior written instructions of Redarc will not be accepted by Redarc.
10. Without limiting any other clause in this Warranty, Redarc has the right to reject any warranty claim made by a Purchaser pursuant to this Warranty where:
  - 10.1 the Purchaser does not notify Redarc in writing of a warranty claim within relevant warranty period applicable to that Solar Product;
  - 10.2 the Purchaser does not notify Redarc in writing of a warranty claim within 1 month of becoming aware of the relevant circumstances giving rise to the claim, so that any further problems with the Solar Product are minimised;
  - 10.3 the serial number of the Solar Product has been altered, removed or made illegible without the written authority of Redarc;
  - 10.4 the Purchaser is unable to provide proof of purchase documentation in accordance with clause 9.4 or evidence that the Solar Product was properly installed, and that proper maintenance has been performed on the Solar Product, by, or

under the supervision of, a qualified auto electrician or technician, in accordance with the instructions of Redarc.

11. If the Solar Product is found to be working satisfactorily on return to Redarc or upon investigation by Redarc, the Purchaser must pay Redarc's reasonable costs of testing and investigating the Solar Product in addition to shipping and transportation charges. Where Redarc is in possession of the Solar Product, the Solar Product will be returned to the Purchaser on receipt of the amount charged.
12. Any replaced Solar Products or components of Solar Products shall become the property of Redarc.
13. Redarc may, in exercise of its sole discretion, deliver another type of Solar Product or component of a Solar Product (different in size, colour, shape, weight, brand and/or other specifications) in fulfilling its obligations under this Warranty, in the event that Redarc has discontinued manufacturing or supplying the relevant Solar Product or component at the time of the warranty claim, or where such Solar Product or component is superior to that originally purchased by the Purchaser.

#### **Other conditions of Warranty**

14. If the Purchaser acquired a Solar Product for the purpose of resupply, then this Warranty shall not apply to that Solar Product.
15. In particular, the sale of a Solar Product via an online auction, online store or other internet website by a party that is not an authorised distributor or reseller of the Solar Product will be deemed to be a resupply within the meaning of the Australian Consumer Law and will render this Warranty void, as Redarc has no control over the storage, handling, quality or safety of Solar Products sold by such persons.
16. A Purchaser shall only be entitled to the benefit of this Warranty after all amounts owing in respect of the Solar Product have been paid.
17. While Redarc warrants that the Solar Products will be free from defects in materials and workmanship in the circumstances set out in this Warranty, to the maximum extent permitted by law Redarc does not warrant that the operation of the Solar Products will be uninterrupted or error-free.
18. To the maximum extent permitted by law, Redarc's determination of the existence of any defect and the cause of any defect will be conclusive.
19. Spare parts or materials for the Solar Products are guaranteed to be available for a period of at least 2 years after purchase of the Solar Products.
20. The agents, officers and employees of any distributor or reseller of the Solar Products and of Redarc are not authorised to vary or extend the terms of this Warranty.
21. Redarc shall not be responsible or liable to the Customer or any third party in connection with any non-performance or delay in performance of any terms and conditions of this Warranty, due to acts of God, war, riots, strikes, warlike conditions, plague or other epidemic, fire, flood, blizzard, hurricane, changes of public policies, terrorism and other events which are beyond the control of Redarc. In such circumstances, Redarc may suspend performance of this Warranty without liability for the period of the delay reasonably attributable to such causes.
22. If a clause or part of a clause in this Warranty can be read in a way that makes it illegal, unenforceable or invalid, but can also be read in a way that makes it legal, enforceable and valid, it must be read in the latter way. If any clause or part of a clause in this Warranty is illegal, unenforceable or invalid, that clause or part is to be treated as removed from this Warranty, but the rest of this Warranty is not affected.

#### **Redarc's contact details**

23. Redarc's contact details for the sending of warranty claims under the Warranty are:

Redarc Electronics Pty Ltd

23 Brodie Road (North), Lonsdale SA 5160

Email: [power@redarc.com.au](mailto:power@redarc.com.au)

Telephone: +61 8 8322 4848

## AUSTRALIAN DESIGNED AND ENGINEERED

---

This product has been specified and tested in Australia in accordance with REDARC specifications and testing requirements by REDARC Engineers. You can be assured that this product meets the stringent quality levels of all REDARC products.



For free technical assistance please contact  
Redarc Electronics  
23 Brodie Road North, Lonsdale SA  
(08) 8322 4848  
[power@redarc.com.au](mailto:power@redarc.com.au)  
[www.redarcsolar.com.au](http://www.redarcsolar.com.au)

Copyright © 2011 Redarc Electronics Pty Ltd. All rights reserved.

This product is manufactured in China.